

Ball Valve (VS), 1/2", 2-way, Cv 1



2-year warranty

Type overview

Type	DN
B2050VS-01	15

Technical data

Functional data	Valve size [mm]	0.5" [15]
	Fluid	chilled or hot water, up to 60% glycol, steam
	Fluid Temp Range (water)	-30...138°C [-22...280°F]
	Body Pressure Rating	600 psig WOG
	Close-off pressure Δps	600 psi
	Flow characteristic	modified equal percentage
	Leakage rate	ANSI Class VI
	Pipe connection	Internal thread NPT (female)
	Max Differential Pressure (Steam)	35 psi
	Flow Pattern	2-way
	Controllable flow range	90° rotation
	Cv	1
	Maximum Inlet Pressure (Steam)	35 psi [241 kPa]
	Maximum Velocity	15 FPS
	Materials	Valve body
Housing seal		PTFE
Stem		316 stainless steel
Stem seal		RPTFE
Seat		RPTFE
Lock nut		stainless steel
Retainer		B16 Brass
Ball		316 stainless steel
Suitable actuators	Non Fail-Safe	LMB(X) GRCB(X) GRB(X)
	Spring	LF

Safety notes



- **WARNING:** This product can expose you to lead which is known to the State of California to cause cancer and reproductive harm. For more information go to www.p65warnings.ca.gov

Product features

Application This valve is typically used in air handling units on heating or cooling coils, and fan coil unit heating or cooling coils. Some other common applications include Unit Ventilators, VAV Box re-heat coils and bypass loops. This valve is suitable for use in a hydronic system with variable flow.

This valve is designed with MFT functionally which facilitates the use of various control input.

Up to 35 psi steam

1/2" - 2" 600 PSIG WOG, Cold Non-Shock

Federal Specification: WW-V-35C, Type II

Composition: BZ

Style: 3

Flow/Mounting details

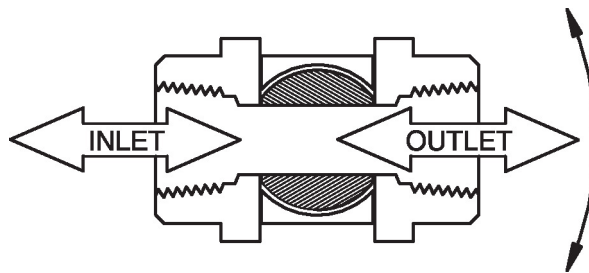

Dimensions

Type	DN	Weight
B2050VS-01	15	0.53 lb [0.24 kg]

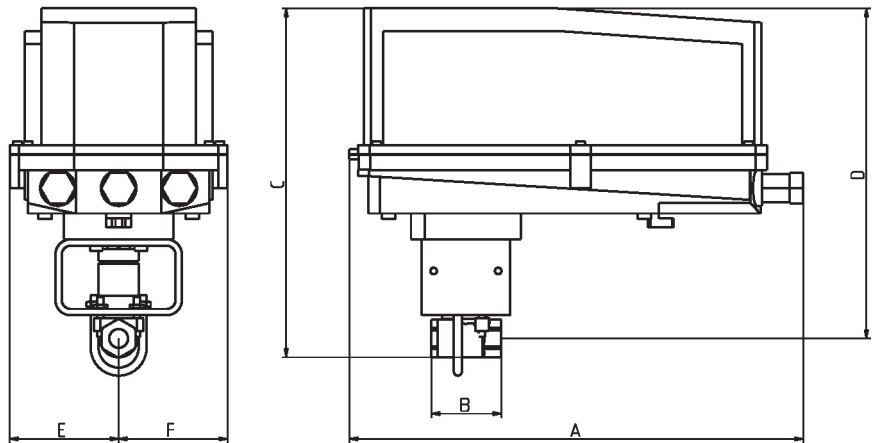

B2050VS..+GRC..N4

A	B	C	D	E	F
14.1" [358]	2.2" [56]	10.9" [277]	10.28" [261]	3.4" [86]	3.4" [86]

MFT/programmable, Non fail-safe, 24 V



5-year warranty



Technical data

Electrical data	Nominal voltage	AC/DC 24 V
	Nominal voltage frequency	50/60 Hz
	Nominal voltage range	AC 19.2...28.8 V / DC 21.6...28.8 V
	Power consumption in operation	8 W
	Power consumption in rest position	2.5 W
	Transformer sizing	11 VA
	Electrical Connection	Terminal blocks
	Overload Protection	electronic throughout 0...90° rotation
Functional data	Operating range Y	2...10 V
	Operating range Y note	4...20 mA w/ ZG-R01 (500 Ω, 1/4 W resistor)
	Input impedance	600 Ω
	Operating range Y variable	Start point 0.5...30 V End point 2.5...32 V
	Operating modes optional	variable (VDC, on/off, floating point)
	Position feedback U	2...10 V
	Position feedback U note	Max. 0.5 mA
	Position feedback U variable	VDC variable
	Direction of motion motor	selectable with switch 0/1
	Manual override	under cover
	Angle of rotation	90°
	Angle of rotation note	adjustable with mechanical stop
	Running Time (Motor)	150 s / 90°
	Running time motor variable	90...150 s
	Noise level, motor	45 dB(A)
Position indication	Mechanical, 30...65 mm stroke	
Safety data	Power source UL	Class 2 Supply
	Degree of protection IEC/EN	IP66/67
	Degree of protection NEMA/UL	NEMA 4X
	Housing	UL Enclosure Type 4X
	Agency Listing	cULus acc. to UL60730-1A/-2-14, CAN/CSA E60730-1:02, CE acc. to 2014/30/EU and 2014/35/EU









Technical data

Safety data	Quality Standard	ISO 9001
	Ambient humidity	Max. 100% RH
	Ambient temperature	-22...122°F [-30...50°C]
	Ambient temperature note	-40...50°C [104...122°F] for actuator with integrated heating
	Storage temperature	-40...176°F [-40...80°C]
	Servicing	maintenance-free
Weight	Weight	6.9 lb [3.1 kg]
Materials	Housing material	Die cast aluminium and plastic casing
Footnotes	†Rated Impulse Voltage 800V, Type of action 1.AA, Control Pollution Degree 3	



Accessories

Gateways	Description	Type
	Gateway MP to BACnet MS/TP	UK24BAC
	Gateway MP to Modbus RTU	UK24MOD
	Gateway MP to LonWorks	UK24LON
Electrical accessories	Description	Type
	Battery backup system, for non-spring return models	NSV24 US
	Battery, 12 V, 1.2 Ah (two required)	NSV-BAT
	Auxiliary switch 1x SPDT add-on	S1A
	Auxiliary switch 2x SPDT add-on	S2A
	Feedback potentiometer 140 Ω add-on, grey	P140A GR
	Feedback potentiometer 1 kΩ add-on, grey	P1000A GR
	Feedback potentiometer 10 kΩ add-on, grey	P10000A GR
	Feedback potentiometer 2.8 kΩ add-on, grey	P2800A GR
	Feedback potentiometer 500 Ω add-on, grey	P500A GR
	Feedback potentiometer 5 kΩ add-on, grey	P5000A GR
Tools	Description	Type
	Connecting cable 10 ft [3 m], A: RJ11 6/4 ZTH EU, B: 3-pin Weidmüller and supply connection	ZK4-GEN
	Service tool, with ZIP-USB function, for configurable and communicative Belimo actuators, VAV controller and HVAC performance devices	ZTH US
Factory add-on option only	Description	Type
	Heater, with adjustable thermostat	ACT_PACK_H

Electrical installation
 **INSTALLATION NOTES**

-  Provide overload protection and disconnect as required.
-  Actuators may also be powered by DC 24 V.
-  Only connect common to negative (-) leg of control circuits.
-  A 500 Ω resistor (ZG-R01) converts the 4...20 mA control signal to 2...10 V.
-  Control signal may be pulsed from either the Hot (Source) or Common (Sink) 24 V line.
-  For triac sink the Common connection from the actuator must be connected to the Hot connection of the controller. Position feedback cannot be used with a triac sink controller; the actuator internal common reference is not compatible.
-  IN4004 or IN4007 diode. (IN4007 supplied, Belimo part number 40155).
-  Actuators are provided with a numbered screw terminal strip instead of a cable.
-  Actuators may be controlled in parallel. Current draw and input impedance must be observed.

Electrical installation

-  Master-Slave wiring required for piggy-back applications. Feedback from Master to control input(s) of Slave(s).
-  Meets cULus requirements without the need of an electrical ground connection.
-  **Warning! Live electrical components!**
During installation, testing, servicing and troubleshooting of this product, it may be necessary to work with live electrical components. Have a qualified licensed electrician or other individual who has been properly trained in handling live electrical components perform these tasks. Failure to follow all electrical safety precautions when exposed to live electrical components could result in death or serious injury.

Wiring diagrams

On/Off

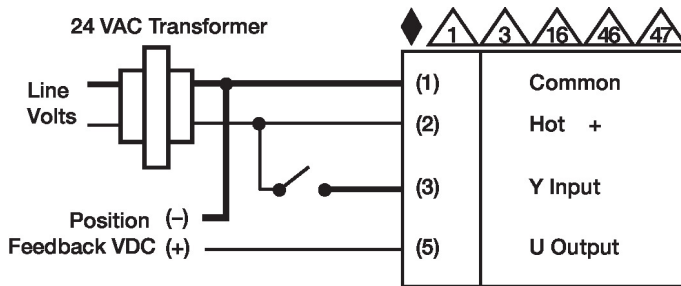

Floating Point

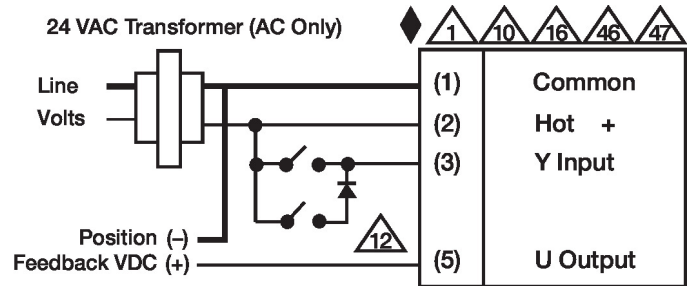

VDC/mA Control

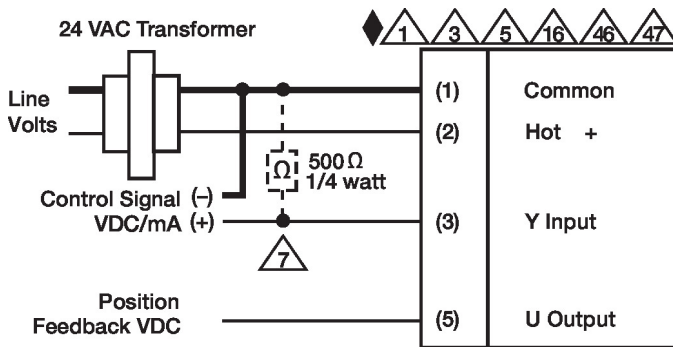

Primary - Secondary

