



Flush-mounted room thermostat

RDU340

- for CAV / VAV heating and cooling systems
- for AHU systems
- for universal heating and cooling systems

-
- **Modulating PI control**
 - **Control depending on the room or the return air temperature**
 - **Output for a DC 0...10 V actuator and AC 230 V electric heater (ON/OFF)**
 - **Automatic or manual heating/cooling changeover**
 - **Operating modes: Comfort, Economy and Protection**
 - **Two multifunctional inputs for keycard contact, external sensor, etc.**
 - **Adjustable commissioning and control parameters**
 - **Minimum and maximum setpoint limitation**
 - **Adjustable minimum and maximum limitation for air flow signal DC 0...10 V**
 - **Output signal inversion as an option (DC 0...10 V → DC 10...0 V)**
 - **Mounting on recessed square conduit box, 60.3 mm fixing centers**
 - **AC 24 V operating voltage**
 - **User and parameter settings can be retained or restored with power loss**

Use

Control of the room temperature in individual rooms of ventilation or air conditioning plants that are:

- Heated or cooled by single duct.
- Heated or cooled by single duct with electric heater.

The RDU340 is suitable for use with VAV systems in connection with the VAV compact controllers types G...B181.1E/3.

The RDU340 can also be used as an AHU temperature controller in connection with valve actuators, as well as for universal heating and cooling applications with DC 0...10 V actuators.

The RDU340 controls

- One DC 0...10 V actuator
- One DC 0...10 V actuator and AC 230V 1-stage electric heater

Use in systems with:





- Heating or cooling mode
- Automatic heating/cooling changeover
- Manual heating/cooling changeover
- Heating and cooling single duct (single duct with electric heater)

Functions

- Maintain room temperature via built-in temperature sensor or external room temperature / return air temperature sensor
- Automatic or manual changeover between heating and cooling mode
- Select applications via DIP switches
- Select operating mode via the operating mode button on the thermostat
- Display current room temperature or setpoint in °C and/or °F.
- Minimum and maximum setpoint limitation
- Key lock (automatic and manual)
- Two multifunctional inputs, freely selectable for:
 - Operating mode switchover contact (key card)
 - Automatic heating/cooling changeover sensor
 - External room temperature or return air temperature sensor
 - Dewpoint sensor.
 - Electric heater enable
 - Alarm input
- Minimum and maximum limitation of air flow signal DC 0...10 V
- Reload factory settings for commissioning and control parameters

Applications

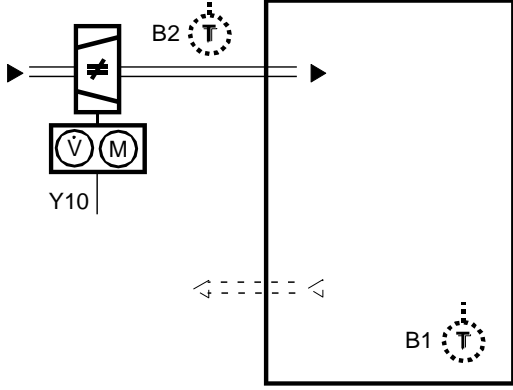
Prior to snapping the front panel to the base, use the DIP switches on the inner side of the front panel to commission the thermostat's applications and the behavior of the output signal.

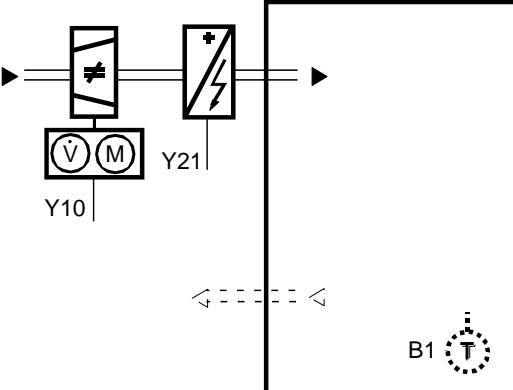
Application and output signal, DIP switches, diagram	
<p>Single duct, Heating or cooling Modulating, DC 0...10 V output signal normal (Factory setting)</p> 	<p>Single duct, Heating or cooling Modulating, DC 0...10 V output signal inverted</p> 
	
<p>Single duct with electrical heater, Cooling and heating, with auxiliary heater Modulating, DC 0...10 V output signal normal Note: on-off electrical heater</p> 	<p>Single duct with electrical heater, Cooling and heating, with auxiliary heater DC 0...10 V output signal inverted Note: on-off electrical heater</p> 
	

V1 Heating or heating / cooling valve actuator

B1 Return air temperature sensor or external room temperature sensor (optional)

E1 Electric heater















B2 Changeover sensor (optional)

Note During startup, the thermostat reloads the control parameter factory settings after each DIP switch settings change.

Type summary

Product no.	Operating voltage	Control output			Backlit LCD	Infrared receiver	Housing color
		3-pos	on/off	DC 0...10 V			
RDU340	AC 24 V	--	✓	✓			white

Equipment combinations

	Designation	Product no.	Data Sheet ¹⁾
DC 0...10 V actuator	Cable temperature sensor or changeover sensor, cable length 2.5 m NTC (3 kΩ at 25 °C)	 QAH11.1	1840
	Room temperature sensor NTC (3 kΩ at 25 °C)	 QAA32	1747
	Electrical actuator, DC 0...10 V (for radiator valve)	 SSA61...	4893
	Electrical actuator, DC 0...10 V (for 2- and 3-port valves / V...P45)	 SSC61...	4895
	Electrical actuator, DC 0...10 V (for small valve 2.5 mm)	 SSP61...	4864
	Electrical actuator, DC 0...10 V (for small valves 5.5 mm)	 SSB61...	4891
	Electrical actuator, DC 0...10 V (for CombiValves VPI45)	 SSD61...	4861
	Electromotoric actuator, DC 0...10 V (for valves 5.5 mm)	 SQS65...	4573
	Electrothermal actuator, AC 24 V, NC, DC 0...10 V, 2 m (for radiator valves and small valve 2.5 mm)	 STA63	4884
	Electrothermal actuator, AC 24 V, NO, DC 0...10 V, 2 m (for radiator valves and small valve 2.5 mm)	 STP63	4884
	DC 0...10 V damper / valve actuator	 GQD161...	4605
		 GDB161... GLB161...	4634
			GMA161...
 GEB161...		4621	
 GCA161... GBB161... GIB161...		4613	
		4626	

VAV compact controller		GDB181.1E/3	3544
------------------------	---	-------------	------

*) The documents can be downloaded from <http://siemens.com/bt/download>.

Accessories

Designation	Product no.	Data Sheet ^{*)}
Changeover mounting kit (50 pcs/package)	ARG86.3	N3009
Plastic mounting spacer for flush mounted thermostats for increasing the headroom in the conduit box by 10 mm	ARG70.3	N3009
Conduit box for flush mounted thermostat	ARG71 / S55770-T137	N3009

*) The documents can be downloaded from <http://siemens.com/bt/download>.

Ordering

When ordering, indicate both product number and designation:

E.g. **RDU340 room thermostat**

Order valve actuators separately.

Mechanical design

The thermostat consists of 2 parts:

- Front panel accommodating the electronics, operating elements and built-in room temperature sensor.
- Mounting base with the power electronics.

The rear of the mounting base contains the screw terminals. The base fits on a square conduit box with 60.3 mm fixing centers. Slide the front panel in the mounting base and snap on.

Operation and settings

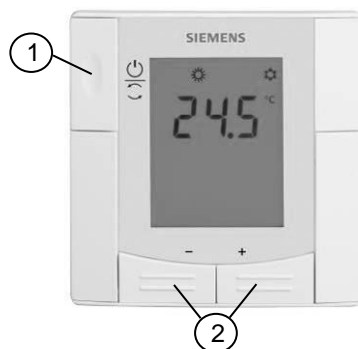

1. Operating mode selector / Protection
2. Adjust setpoint and control parameters

Display

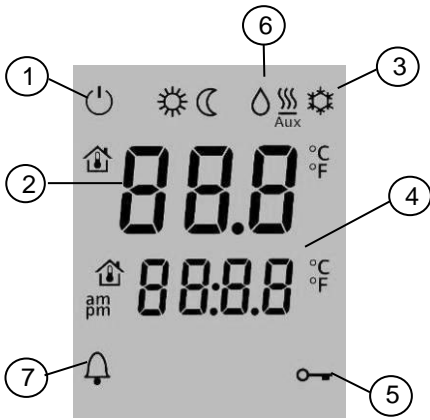

1. Operating mode
 ⏻ Protection
 ☀ Comfort
 🌙 Economy

2. Display room temperature, setpoints and control parameters.
 🏠 Symbol used to display the current room temperature

3. Heating/cooling mode
 ⚙ Cooling mode
 🔥 Heating mode,
 🔥
 Aux Electric heater active

4. Additional user information

5. Key lock active

6. Condensation in room (dewpoint sensor active)

7. Indicate fault or reminder

Mounting and installation

Mount the room thermostat on a recessed square conduit box with 60.3mm fixing centers. Do not mount on a wall in niches or bookshelves, behind curtains, above or near heat sources, or exposed to direct solar radiation. Mount about 1.5 m above the floor.

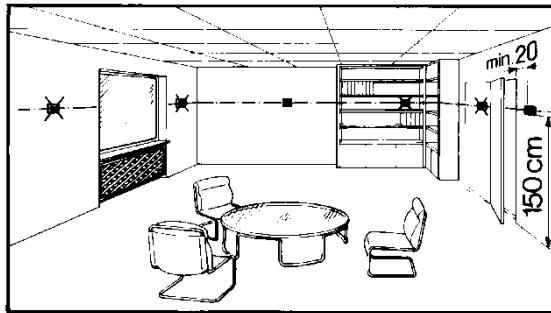

Mounting



- Devices must be mounted on clean, dry indoor place without direct airflow from a heating / cooling device, and not be exposed to dripping or splashing
- In case of limited space in the conduit box use the mounting bracket ARG70.3 to increase the headroom by 10 mm

Wiring



See the mounting instructions M3078 enclosed with the thermostat.

- Comply with local regulations to wire, protection and earth the thermostat.
- The power supply line must have a circuit breaker with a rated current of no more than 10 A. For US installations use Class 2 rated power supplies.

Warning!

No internal line protection for supply lines to external consumers (Y10, Y21)

Risk of fire and injury due to short-circuits!

- Adapt the line diameters as per local regulations to the rated value of the installed overcurrent protection device.
- Isolate the cables of SELV inputs X1-M/X2-M if the conduit box carries AC 230 V mains voltage.
- Inputs X1-M or X2-M of different units (e.g. summer/winter switch) may be connected in parallel with an external switch. Consider overall maximum contact sensing current for switch rating.
- No metal conduits

- No cables provided with a metal shield
- Disconnect from supply before opening the cover

Commissioning

Set the thermostat application via the DIP switches before snapping the front panel on the mounting base.

After power is applied, the thermostat carries out a reset during which all LCD segments flash indicating that the reset was correct. After the reset, which takes about 3 seconds, the thermostat is ready for commissioning by qualified HVAC staff. The control parameters of the thermostat can be set to ensure optimum performance of the entire system (see basic documentation P3078).

Note After powerfail the thermostat restarts in the same mode as before.

Control sequence

- The control sequence may need to be set via parameter P01 depending on the application. The factory setting for the single duct application is “Cooling only”.

Calibrate sensor

- Recalibrate the temperature sensor if the room temperature displayed on the thermostat does not match the room temperature measured (after min. 1 hour of operation). To do this, change parameter P05.

Setpoint and range limitation

- We recommend to review the setpoints and setpoint ranges (parameters P08...P12) and change them as needed to achieve maximum comfort and save energy.

Disposal





This symbol or any other national label indicate that the product, its packaging, and, where applicable, any batteries may not be disposed of as domestic waste. Delete all personal data and dispose of the item(s) at separate collection and recycling facilities in accordance with local and national legislation.

For additional details, refer to [Siemens information on disposal](#).

Technical data

⚠ Power supply	Operating voltage	SELV AC 24 V ±20% or AC 24 V class 2 (UL)	
	Rated voltage	AC 24 V	
	Frequency	50/60 Hz	
	Power consumption	Max. 8 VA	
	External supply line protection (EU)	Circuit breaker max. 10 A Characteristic B, C, D according to EN 60898 or Power source with current limitation of max. 10 A	
	⚠ Warning	No internal fuse External preliminary protection with max. C 10 A circuit breaker required in all cases	
		Outputs	
	Control output Y10-G0	SELV DC 0...10 V	
	Resolution	39 mV	
	Current	Max. ±1 mA	
	Control output Y21-L (N.O.)	AC 230 V	
	Rating	5 mA...5(2) A	
⚠ Warning	No internal fuse External preliminary protection with max. C 10 A circuit breaker in the supply line		

	required under all circumstances		
Inputs	Multifunctional input X1-M/X2-M		
	Temperature sensor input:	Type	NTC (3 kΩ at 25 °C)
	Digital input:	Operating action	Selectable (N.O./N.C.)
	Contact sensing		SELV DC 0...5 V/max 5 mA
	Insulation against mains voltage (SELV)		4 kV, reinforced insulation
	Function input:		Selectable
	External temperature sensor, heating/cooling changeover sensor, operating mode switchover contact, dewpoint monitor contact, enable electric heater contact, alarm contact		X1: P38 X2: P40
Operational data	Switching differential, adjustable		
	Heating mode	(P30)	2 K (0.5...6K)
	Cooling mode	(P31)	1 K (0.5...6K)
	Setpoint setting and range		
	 Comfort	(P08)	21°C (5...40 °C)
	 Economy	(P11-P12)	15°C/30°C (OFF, 5...40 °C)
	 Protection	(P65-P66)	8°C/OFF (OFF, 5...40 °C)
	Multifunctional input X1/X2	Selectable 0...6	
	Input X1	Factory setting = 3 (P38)	Operating mode switchover
	Input X2	Factory setting = 2 (P40)	Heat/cool changeover sensor
	Built-in room temperature sensor		
	Measuring range	0...49 °C	
	Accuracy at 25 °C	< ± 0.5 K	
	Temperature calibration range	± 3.0 K	
	Settings and display resolution		
Setpoints	0.5 °C		
Current temperature value displayed	0.5 °C		
Environmental conditions	Storage	As per IEC 60721-3-1	
	Climatic conditions	Class 1K3	
	Transport	As per IEC 60721-3-2	
	Climatic conditions	Class 2K3	
	Operation	As per IEC 60721-3-3	
	Climatic conditions	Class 3K5 ¹⁾	
Standards and directives	EU Conformity (CE)	CE1T3076_1 ^{*)}	
	RCM Conformity	CE1T3076_1en_C1 ^{*)}	
	Protective class	II as per EN 60730-1	
	Pollution class	Normal	
	Degree of protection of housing	IP 30 to EN 60529	
	Housing flammability class according to UL94	V-0	
Environmental compatibility	The product environmental declaration CE1E3076_1 ^{*)} contains data on environmentally compatible product design and assessments (RoHS compliance, materials composition, packaging, environmental benefit, disposal).		
General	Connection terminals	Solid wires or prepared stranded wires 1 x 0.4...1.5 mm ²	
	Housing front color	RAL 9003 white	
	Weight	0.220 kg	

*) The documents can be downloaded from <http://siemens.com/bt/download>.

1) No condensation is allowed.

Connection terminals

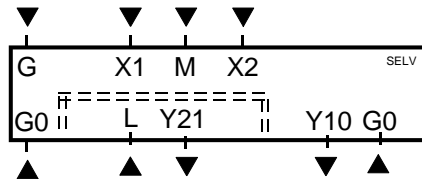

G, G0	Operating voltage thermostat AC 24 V
L	Operating voltage for electric heater AC 230 V
Y21	Control output for electric heater
Y10	Control output for DC 0...10 V actuator
X1, X2	Multifunctional input for temperature sensor (e.g. QAH11.1) or switch
M	Measuring neutral for sensor and switch

Connection diagrams

Application:

Single duct in VAV/CAV

Heating or cooling for universal or AHU

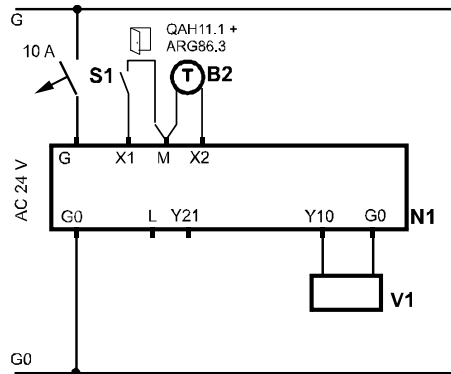

G - G0 AC 24 V

N1	Room thermostat RDU340
V1	VAV / CAV system, DC 0...10V actuator for heating or cooling
S1	Operating mode switch-over contact (e.g. key card)
B2	Heat/cool changeover sensor

Application:

Single duct with electric heater in VAV/CAV

Heating and cooling with electric heater for universal or AHU

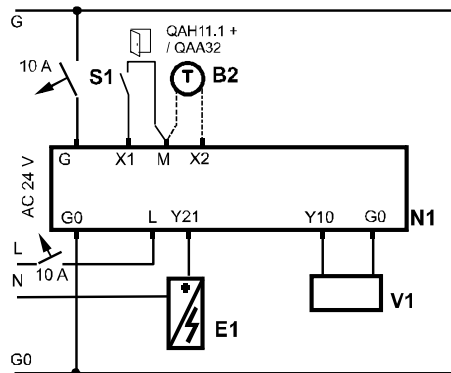

G - G0, Y10 AC 24 V
L - N, Y21 AC 230 V

N1	Room thermostat RDU340
V1	VAV / CAV system, DC 0...10V actuator for heating or cooling
E1	Electric heater
S1	Operating mode switch-over contact (e.g. key card)
B2	Heat/cool changeover sensor

Warning

For US installations use Class 2 rated power supplies.

For other installations use circuit breakers with rated current of no more than 10 A.

Dimensions

Dimensions in mm

